



595J07N00

## Table of Contents

---

<b>A</b>	WARNINGS AND SAFETY NOTICES .....	1
<b>B</b>	ERGONOMICS RECOMMENDATIONS .....	7
<b>C</b>	WARRANTY TERMS AND EXCLUSIONS .....	8
<b>D</b>	GENERAL INFORMATION.....	9
<b>E</b>	TRANSPORT, HANDLING, AND STORAGE .....	10
<b>F</b>	INSTALLATION AND ASSEMBLY .....	11
<b>G</b>	USE .....	13
<b>H</b>	CLEANING AND MAINTAINING THE APPLIANCE .....	16
<b>I</b>	TROUBLESHOOTING .....	18

## A WARNINGS AND SAFETY NOTICES

---

### General Information

---

To be able to use this appliance safely and understand the Manual correctly, we recommend you become familiar with the terms and symbols used in the documentation. To easily distinguish and recognize the different types of hazard, this Manual uses the following symbols:



#### **WARNING**

Danger to the health and safety of users



#### **WARNING**

Risk of electrocution – hazardous voltage.



#### **CAUTION**

Risk of deterioration to the appliance or product being processed.



#### **IMPORTANT**

Instructions or important information about the product



#### **Electrical bonding**



Please read all the instructions before using the appliance



#### **Details and explanations**

# Important Safety Notices

---

**This User Manual contains practical information for the user on how to work correctly and in complete safety, and is designed to make it easier to use the machine (called “machine” or “appliance” below).**

What follows is in no case intended to be a long list of warnings and constraints, but rather a series of instructions meant to improve the service provided by the machine in every respect, and particularly to avoid a series of injuries or damage to equipment that might result from inappropriate procedures for use and management.

**It is essential that all the people responsible for transporting, installing, commissioning, using, maintaining, repairing, or dismantling the machine should consult this manual and read it carefully before proceeding with the various operations, in order to avoid any incorrect or inappropriate handling that might result in damage to the machine or put people’s safety at risk.**

**It is just as important that the Manual should always be available to the operator and it should be kept carefully where the machine is used ready for easy and immediate consultation in case of any doubt, or in any case, whenever the need arises.**

If after reading the Manual, there are still any doubts concerning how to use the machine, please do not hesitate to contact the Manufacturer or approved after-sales agent, who is constantly on hand to ensure quick and careful service for improved machine operation and optimum efficiency.

- **Read the Manual carefully before using the appliance.**
- **Keep the Manual in a safe place so it can be referred to after installation.**
- **Always install the appliance in a well ventilated place.**



## **In an Emergency**

- **Keep emergency phone numbers in a visible place.**
- **Installation and maintenance must be carried out only by specialized technicians approved by the manufacturer. If you need assistance, please contact an approved after-sales agent. Always use genuine spare parts.**
- **This appliance can be used by children aged from 8 years and above and persons with reduced physical, sensory or mental capabilities or lack of experiences and knowledge if they have been given supervision or instructions concerning use of the appliance in safe way and understand the hazards involved.**
- **Cleaning and user maintenance shall not be made by children without supervision.**
- **Children being supervised not to play with the appliance.**
- **Personnel using the appliance must have received specific training on the risks involved.**
- **Use the appliance only under supervision.**
- **Unplug the appliance in the event of a breakdown or malfunction.**
- **Do not use products (even if diluted) containing chlorine (sodium hypochlorite, hydrochloric or muriatic acid, ammonium chloride, etc.) to clean the appliance.**
- **Do not use metal utensils (Scotch Brite brushes or scouring sponges) to clean the appliance.**
- **Avoid oil or grease coming into contact with plastic parts.**
- **Ensure that dirt, grease, food, or other substances do not settle on the appliance.**
- **Do not wash the appliance with direct water jets or steam cleaners.**
- **You can obtain this Manual in digital format (PDF) by contacting the dealer or your local after-sales agent or by scanning the QR code on the appliance.**
- **Scan the QR code on appliance backside to access videos tutorials, user manuals in other languages and other support material.**
- **Install a protective switch upstream of the appliance.**
- **The opening of contacts and the maximum dispersal current must comply with current regulations.**
- **We advise having the appliance inspected by a certified technician at least every 12 months.**
- **We recommend taking out a service contract.**
- **People with pacemakers should consult their doctor to see if their safety is guaranteed when using this type of appliance.**



- The symbol  on the product indicates that it should not be considered as household waste, but should be disposed of according to applicable standards, in order to avoid any negative impact on the environment and human health.

For more information on recycling this appliance, contact your local agent or dealer of the appliance, the after-sales agent or the local authority responsible for the disposal of waste.



- The “Refer to the User Manual” symbol  indicates that the User Manual should be read before continuing to use the appliance.
- If the power cord is damaged, it must be replaced by the Manufacturer, a certified service agent or qualified service personnel, to avoid risk.
- Always start on a slow speed setting (variable speed models).
- Do not try to insert a finger or object while the machine is running.
- Always unplug the machine before any kind of intervention.
- Handle rotors with the utmost care. (Risk of CUTS – ELECTRIC SHOCK).
- Do not put the motor unit in a dishwasher for cleaning. Wipe the unit with a damp sponge and a little detergent, then dry it.
- Avoid mishandling the appliance and accessories.
- Be careful not to cut yourself with blades during cleaning.
- If the appliance stops during use:
  - Unplug it and let it cool down until the heat protection resets or reset the circuit breaker. See Section “I” for troubleshooting.

If problems persist, contact your local dealer’s after-sales agent.

- These appliances are designed to be used in commercial settings, such as kitchens, restaurants, canteens, hospitals, or commercial business, such as bakeries, butchers, but not for continuous mass food production.
- Only specialized technicians are allowed to carry out repairs on the appliance.
- Keep all packaging and detergents out of reach of children.
- Do not store explosive substances, such as pressurized containers containing a flammable product, next to this appliance.
- Do not remove, falsify, or make the machine’s labeling illegible.
- When the appliance comes to be decommissioned, the marking will have to be removed with it.

Failure to comply with the above instructions may compromise the safety of the appliance.

The guarantee is void if these instructions are not followed.

The manufacturer disclaims any responsibility for any damage or malfunctions resulting from:

- Failure to comply with the instructions given in this Manual
- Incorrect repairs and replacement using parts other than those specified in the spare parts catalog (the assembly and use of non-genuine parts and accessories may interfere with the operation of the machine and cause the warranty to expire)
- Unauthorized changes or repairs
- Inadequate maintenance
- Improper use of the machine
- Unforeseeable exceptional events
- Use of the machine by unqualified and untrained personnel
- Non-application of the country’s hygiene, health, and safety provisions in the workplace.

The manufacturer disclaims any liability for damage resulting from any conversions or modifications made by the user or the customer.

The responsibility for identifying and selecting the appropriate personal protective equipment to be worn by users is the responsibility of the employer, the person in charge of the workplace, or the after-sales technician, in accordance with the standards in force in the country of use.

Electrolux Professional disclaims any responsibility for any inaccuracies that could have ended up in the Manual, if due to printing or translation errors.

Any future additions to the Installation, Use, and Maintenance Manual that the manufacturer considers useful for the customer must be retained with the Manual and will be an integral part of it.





## RETAINING THE MANUAL

The Manual must be kept for the entire life of the machine until it is disposed of.

In the event that the machine is decommissioned, sold, leased, rented, or loaned, this Manual must accompany the machine.

## Personal Protective Equipment

Below is a summary of Personal Protective Equipment (PPE) to be used during the various phases of using the machine.

Phase	Protective clothing 	Safety shoes 	Gloves 	Glasses 	Safety helmets 
Transport					
Handling					
Unpacking					
Assembly					
Normal use					
Settings					
Routine cleaning					
Exceptional cleaning					
Maintenance					
Disassembly					
Decommissioning					

Legend:

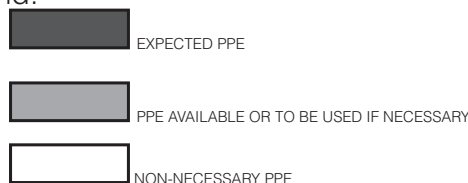

During routine use, gloves protect the hands from contact with hot parts of the appliance or hot foods.

## General Safety



- The appliances are equipped with electrical and/or mechanical safety devices designed to protect users and the appliance.
- It is forbidden to operate the appliance after removing, handling, or damaging the protective devices or safety features.
- Do not modify the parts provided with the appliance under any circumstances.
- Before any maintenance work, unplug the power cord from the wall socket.



## General Safety Guidelines

---

Under no circumstances can the user remove or modify these safety devices. The Manufacturer disclaims any responsibility for the handling or non-use of these devices.

Safety symbols that must be on or near the machine

Prohibited	Meaning
	Do not remove any safety devices
	Do not use water to extinguish fires (on electrical parts)

Danger	Meaning
	Risk of cuts
	Risk of electrocution (electrical parts)

## Warnings for Use and Maintenance

---

- Risks associated with the machine are of a mainly mechanical or electrical nature. These risks have been mitigated where possible:
  - Either directly by adopting appropriate solutions
  - Or indirectly by using screens, guards, and safety devices.
- During maintenance, some risks that cannot be eliminated remain; these must be mitigated by adopting specific behaviors and precautions.
- Inspection, cleaning, repair and maintenance work on moving parts are prohibited. Users should be alerted by clearly visible warnings.
- To ensure the performance and smooth operation of the machine, it is essential to perform maintenance work periodically according to the instructions given in this manual.
- It is advisable to regularly check the proper operation of the safety devices, the insulation of the electrical cables, and the seal which will need to be replaced if necessary.
- Maintenance work on the appliance is reserved exclusively for specialized personnel carrying the necessary personal protective equipment and with appropriate equipment, tools, and aids.
- It is forbidden to operate the machine after removing, handling, or damaging the safety devices.

## Reasonably Foreseeable Improper Use

---

Any use other than that specified in this Manual is considered improper. During the use of the machine, any work or activities different from those intended are considered improper and can generally result in risks to the safety of users and damage to the machine. Reasonably foreseeable improper uses include:

- Lack of maintenance, cleaning, regular checks of the machine
- Changes to the structure or operating logic
- Handling of screens or safety devices
- Non-use of personal protective equipment by users, specialist personnel, and maintenance personnel
- Non-use of appropriate accessories (e.g. unsuitable equipment)
- Storing combustible or flammable materials near the appliance, or in any case, any items that are not compatible or unrelated to the work to be done
- Improper installation of the machine
- Putting into the appliance any objects or items that are incompatible with use or that could harm the machine or people or pollute the environment
- Climbing on the machine
- Non-compliance with the instructions on the intended use of the machine
- Other risky behavior which the Manufacturer cannot rule out

The behaviors described above are prohibited!

## Residual Risk

---

- The machine highlights risks that have not been completely eliminated in the design or installation of appropriate protections. In any event, the user is informed of these risks in this Manual, which specifically indicates the type of personal protective equipment that personnel involved with the machine must be equipped with.

To comply with these conditions, the areas around the machine must always:

- Be cleared (no tools, containers, boxes, etc.)
- Be clean and dry
- Be perfectly lit

To fully inform the customer, the residual risks on the machine are set out below.

Residual risk	Description of a dangerous situation
	The user can cut himself/herself with the blades of the rotor.

## Normal Machine Use

---

- In the event of significant anomalies (e.g. short-circuit, cables disconnected from terminals, motor failures, deterioration of electrical cable protection ducts), the user must immediately unplug the machine and notify the personnel in charge of equipment maintenance.

## Transport, Handling, and Storage

---

- Transport (transfer of the machine from one location to another) and handling (moving within the workplace) must be carried out by personnel with personal protective equipment.

## Cleaning and Maintaining the Appliance

---

- Before cleaning or maintenance, switch off the appliance.
- It is forbidden to remove security devices.
- Use appropriate personal protective equipment.
- Maintenance, checks, and overhaul work must be carried out by specialized personnel only or by an after-sales technician, equipped with all appropriate personal protective equipment, tools, and aids.
- Any repairs on electrical equipment must be carried out exclusively by specialized personnel or by an after-sales technician.
- Respect the requirements for routine and exceptional maintenance work. Failure to comply with these warnings can result in risks to personnel.

## Routine Maintenance

---

- Unplug the appliance before cleaning.
- Do not clean the appliance with water jets or steam cleaners.
- Do not immerse the appliance in water.
- Make sure you use suitable cleaning products to keep the appliance in good and safe working order.
- Before commissioning the appliance, clean all internal parts and accessories with lukewarm water and neutral soap or with products that are more than 90% biodegradable (to reduce the emission of pollutants into the atmosphere); then rinse and dry thoroughly.

Some items are dishwasher-proof (see section on cleaning).

- To clean the appliance, do not use solvent products (trichloroethylene, etc.), powders, or abrasive agents, metal scouring pads, or sponges that can damage surfaces. Avoid using organic solvents and essential oils. These substances could damage the synthetic elements of the appliance.
- Do not use products (even if diluted) containing chlorine (sodium hypochlorite, hydrochloric or muriatic acid, ammonium chloride, etc.).

## Preventive Maintenance

---

- To ensure the safety and performance of your equipment, it is recommended that approved technicians carry out maintenance every 12 months, in accordance with maintenance manuals. For more details, please contact your local after-sales agent.



## Exceptional Repair and Maintenance

---

- Exceptional repairs and maintenance must be carried out exclusively by authorized specialist personnel. The manufacturer disclaims any liability in the event of a failure or damage resulting from measures taken by a technician not authorized by the manufacturer, in which case the manufacturer's original warranty will be invalidated.

## Parts and Accessories

---

- Use genuine accessories and/or spare parts only. The use of non-genuine accessories and/or parts will invalidate the manufacturer's original warranty in addition to the fact that the machine may no longer meet the safety standard.

## Maintenance Intervals

---

- Inspection and maintenance intervals depend on the actual operating conditions of the appliance and environmental conditions (presence of dust, humidity, etc.), which is why we cannot define precise intervals. In any case, we recommend carrying out regular and particularly careful maintenance of the appliance in order to minimize machine downtime.

Maintenance, checks, inspections, and cleaning	Frequency	Responsibility
Ordinary cleaning: <ul style="list-style-type: none"><li>• General cleaning of the appliance and the surrounding area.</li></ul>	Daily	User
Checks: <ul style="list-style-type: none"><li>• Check the mechanical part used to drive the rotors, the seal.</li></ul>	Daily	User (have the seal replaced if defective)
<ul style="list-style-type: none"><li>• Check blades of rotors (wear parts), and change them regularly to maintain the same quality of cutting.</li></ul>	Daily	User
Check the power cable: <ul style="list-style-type: none"><li>• Check the condition of the power cable</li></ul>	Daily	User
Appliance structure: <ul style="list-style-type: none"><li>• Check the tightening of screws, fastening systems, etc.</li></ul>	Annually	Service team
General overhaul of the appliance: <ul style="list-style-type: none"><li>• Check all components, electrical equipment, signs of corrosion, etc.</li></ul>	Annually	Service team

- It is also recommended to take out a preventative and scheduled maintenance contract with your after-sales agent.

## Decommissioning the Machine

---

- Disassembly operations must be carried out by specialized personnel.
- Work on electrical equipment (always powered off) is exclusively reserved for specialized personnel.
- Before you dispose of the appliance, make it unusable by cutting off its power cable.

## B - ERGONOMICS RECOMMENDATIONS

---

The ergonomic features of your product, the ones which may influence your physical and cognitive interaction with it, have been assessed and certified. A product which exhibits ergonomic features, in fact, shall fulfil specific ergonomic requirements, belonging to three different areas: Polytechnic, Biomedical and Psychosocial (usability and satisfaction). For each of these areas, specific tests with real users have been performed. The product was therefore compliant with the ergonomic acceptability criteria requested by the standards applied.

## General recommendations:

The vegetable slicer/ cutter that you use is specifically studied and tested in order to minimize any physical problems associated to the interactions with the product.

Repeated movements for a significant time during machine use operations could lead to stresses on the shoulders and neck.

We point out some operating procedures that we suggest adopting, if they are possible:

- *place the machine on a work top that can be adjusted according to the height of the operator*
- *during prolonged use, take breaks or try to do different tasks (this to avoid continuous operations in the same posture)*
- *avoid movement of the motor base if not necessary*
- *store the accessories/ the various components of the machine near the work-station*

## C - WARRANTY TERMS AND EXCLUSIONS

---

If the purchased product is covered by a warranty, this warranty will comply with local regulations provided that the product is installed and used for its intended purpose and in accordance with the terms described in the relevant equipment documentation.

The warranty only applies if the customer has used genuine spare parts and carried out maintenance in accordance with the user guides and maintenance documentation made available in print or digital format by Electrolux Professional.

Electrolux Professional strongly recommends using Electrolux Professional-approved detergents, rinsing products, and descalers to achieve the best results and to keep the product at its maximum efficiency level over time.

The Electrolux Professional warranty does not cover:

- The technician's travel expenses to deliver or collect the product
- Installation
- Training on use/operation
- Replacement (and/or supply) of wear parts, unless the replacement is the result of material or manufacturing defects reported within one (1) week of the defect being identified
- Fixing external wiring
- Fixing unauthorized repairs or damage, defects, or malfunctions caused and/or resulting from;
  - Inadequate and/or abnormal capacity of electrical systems (current/voltage/frequency, including peaks and/or failures)
  - Negligence, misuse, and/or non-compliance by the customer with the instructions for use and maintenance described in the relevant equipment documentation
  - Improper or inadequate installation procedures, repair, maintenance (including handling, modifications, and repairs by unauthorized third parties) and modification of safety systems
  - Use of non-genuine components (e.g. wear parts or spare parts)
  - Environmental conditions causing thermal stresses (e.g. over-heating/freezing) or chemical stresses (e.g. corrosion/oxidation)
  - Insertion of foreign objects into the product or adding foreign objects to the product
  - Accidents or force majeure
  - Transport and handling, including scratches, bumps, shards and/or other product finish damage, unless contradictory specifications are noted, if such damage is the result of material or manufacturing defects reported within one (1) week of delivery
- Products with the serial number deleted, modified, or no longer legible
- Accessories and software not approved or named by Electrolux Professional.

The warranty does not cover any scheduled maintenance activity (including the parts required for this purpose) or the supply of detergents, unless otherwise stipulated by any local agreement and under local conditions.

For the list of approved after-sales agents, visit the Electrolux Professional website.



## D - GENERAL INFORMATION

Technical features:

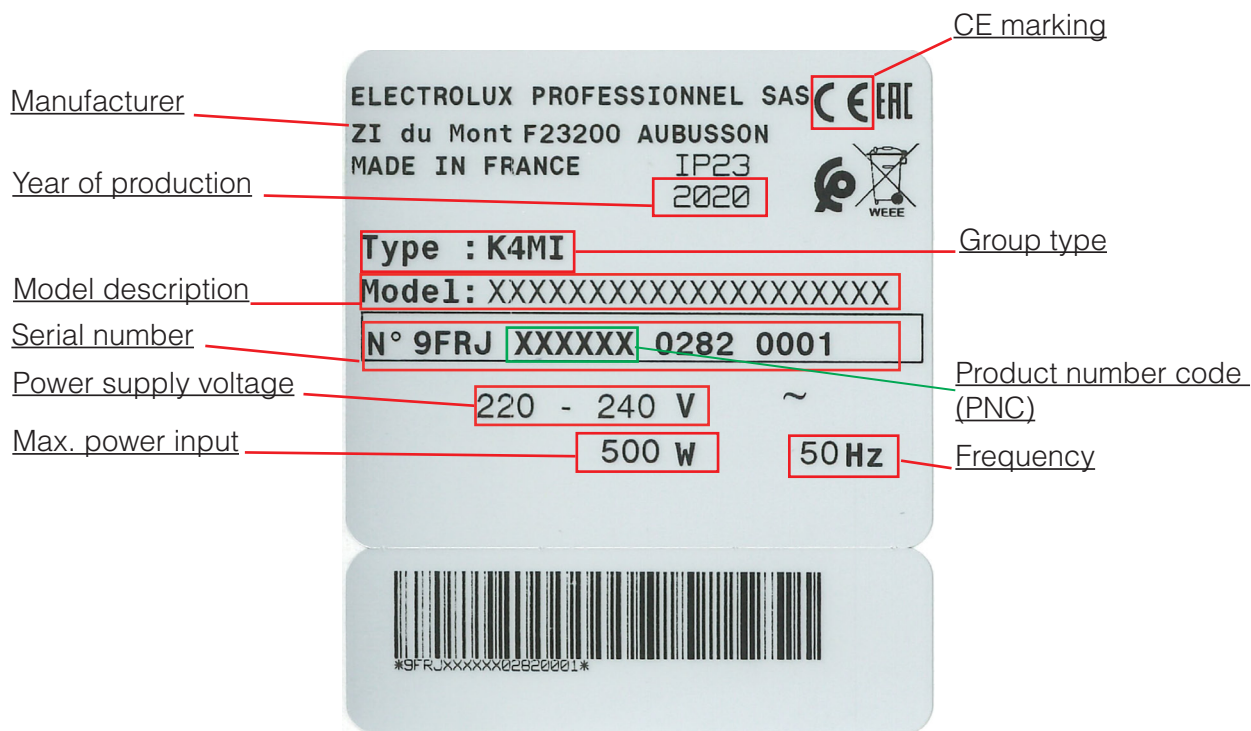
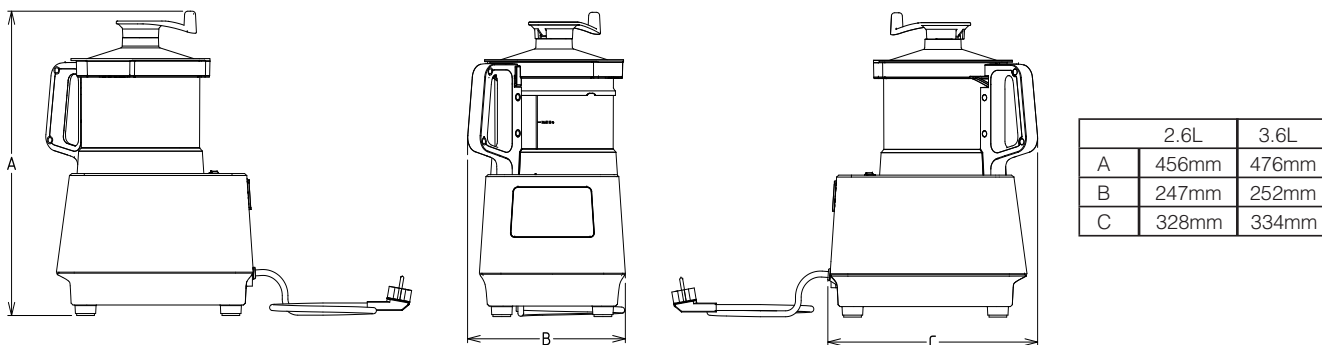

Scan the QR code on appliance backside to access videos tutorials, user manuals in other languages and other support material



### WARNING

See "Warnings and Safety Notices".

## Intended Use and Constraints

This appliance was designed to chop, mix, emulsify food products . Any use other than the one described in this manual is not considered 'normal' by the manufacturer.



### CAUTION

The appliance is not intended for use outdoors or in environments exposed to the elements (rain, direct sunlight, etc.).



### NOTE!

The manufacturer does not accept any responsibility for the use of any appliances other than that provided.

## Installation and Assembly

---

### Setting up

---

- Install the appliance on a flat, stable surface supporting a weight of 15 kg.

### Introduction

---

- The installation and assembly of the machine must be carried out by specialized personnel only, equipped with all appropriate personal protective equipment, equipment, tools, and aids.
- The operations described must be carried out in accordance with current safety standards.
- Before any installation or assembly procedure, turn off the electrical supply to the appliance.

### Electrical Connection

---

- Repairs on electrical systems should be carried out by specialized personnel only.
- The electrical connection of the appliance must be carried out in accordance with the standards and requirements in force in the country of use.
- Refer to the nameplate for information about the appliance's power voltage.
- Any damaged power cable must be replaced by an after-sales technician or specialized personnel to prevent any risk.
- The manufacturer disclaims any responsibility for any damage or accidents resulting from non-compliance with the above guidelines or the electrical safety standards in place in the country of use.
- The connection point is grounded and the mains voltage and frequency match those given on the nameplate. If there is any doubt about the effectiveness of the grounding point, ask specialized staff to check the installation.
- The machine (variable speed appliance) can operate at 50 or 60 Hz and does not need to be configured by the user (see nameplate).

## E - TRANSPORT, HANDLING, AND STORAGE

---



### WARNING

See "Warnings and Safety Notices".

### Unpacking



### IMPORTANT

Check the appliance immediately to ensure that it has not been damaged during transport.

Examine the packaging before and after unloading.

Remove the packaging. When unpacking and handling the appliance, be sure not to cause any impact.



### NOTE!

- *The carrier is responsible for the safety of the goods during transport and delivery.*
- *Report any obvious or hidden damage to the carrier by way of complaint.*
- *If the goods are damaged or the delivery is incomplete, report it on the delivery order.*
- *The driver must sign the transport slip: the carrier may not accept claims if the transport slip is not signed (the carrier can provide the necessary form).*

## Disposing of Packaging

---

Packaging must be disposed of in accordance with regulations in the country of use. All materials used for packaging are environmentally friendly. They can be safely stored, recycled, or burned in a waste incineration facility. Recyclable plastic parts have the following acronyms:



### **PE Polyethylene**

- Covers of the different parts
- Bag containing instructions



### **PP Polypropylene**

- Straps



- Exterior packaging

The wooden and cardboard elements can be disposed of in accordance with the standards in force in the country of use.

## Storage

---

The machine and/or its parts must be stored and protected from moisture, in a non-harsh environment, free of vibrations, and at an ambient temperature of between -25°C and 50°C.

## F - INSTALLATION AND ASSEMBLY

---



### **WARNING**

See “Warnings and Safety Notices”.

## Introduction

---

To ensure the proper operation of the appliance and to comply with the safety conditions during its use, follow the instructions given in this section and in Section A carefully. The manufacturer does not accept responsibility for corrosive effects due to external causes.

## Customer Responsibilities

---

Customer tasks and interventions:

- For more information on the electrical connection, see Electrical Connection
- Check the surface under the machine is level

## Description

- The cutter comes with: rotor, bowl, lid, and scraper.

This cutter mixer was designed to chop, mix, emulsify food products. It will be your partner for all your food prep and will ensure precise results. It is the professional processor for bars, restaurants, communities.

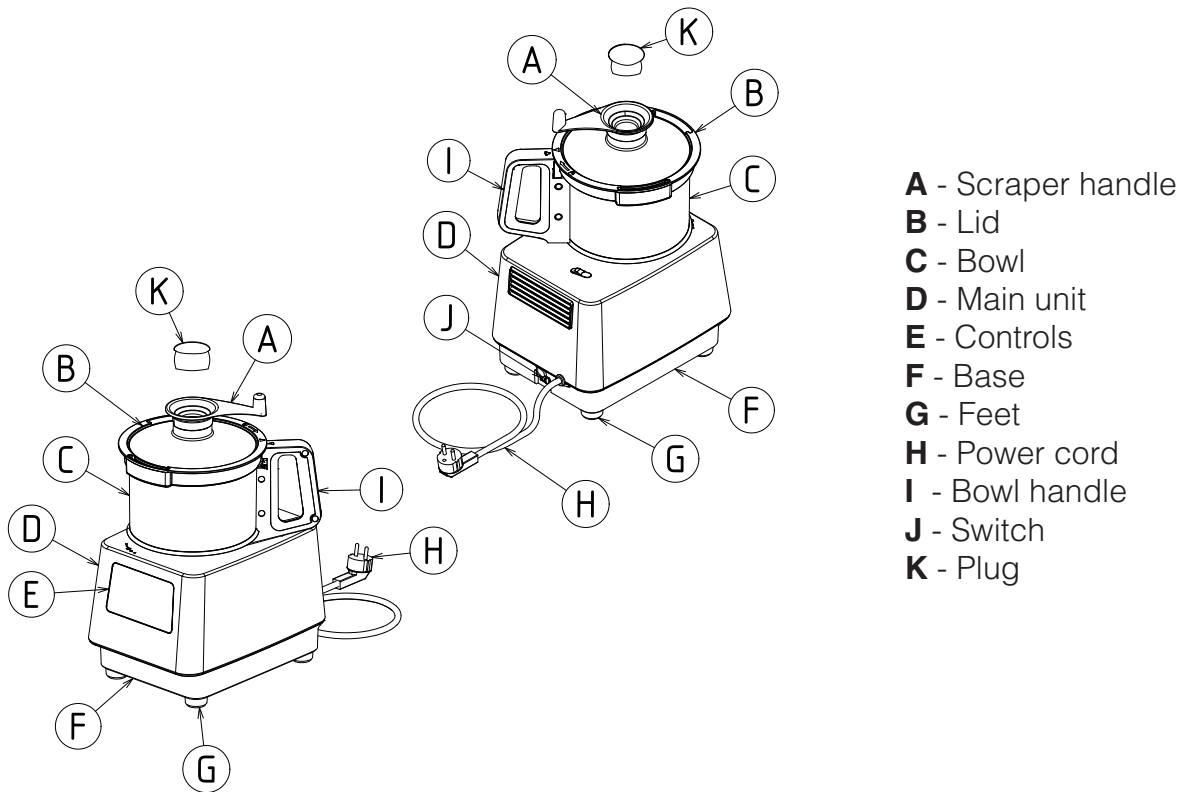

## Overview

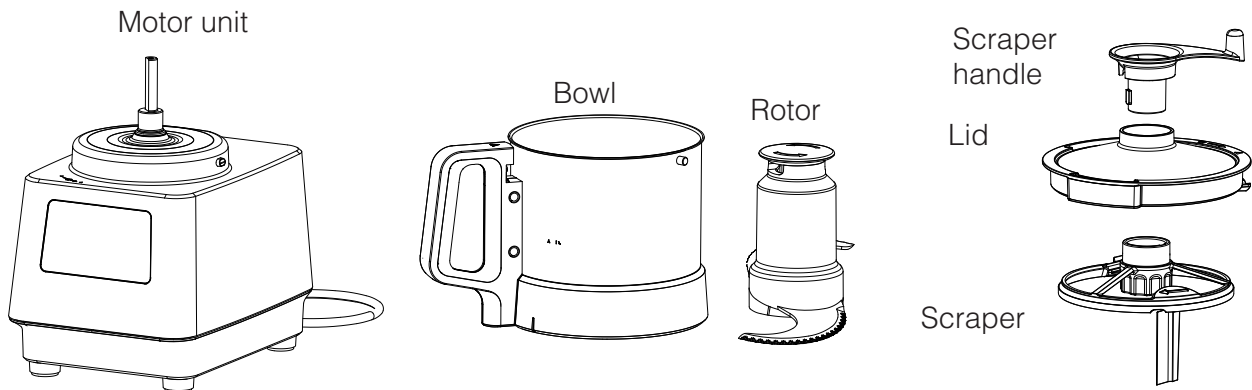

## G - USE

Control panel:

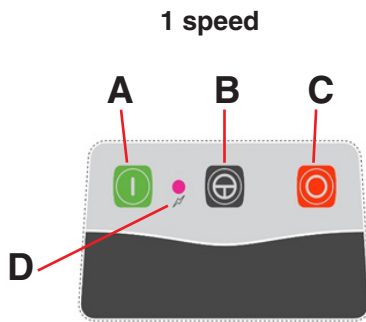

- A. Start button
- B. Pulse button
- C. Stop button
- D. Power light

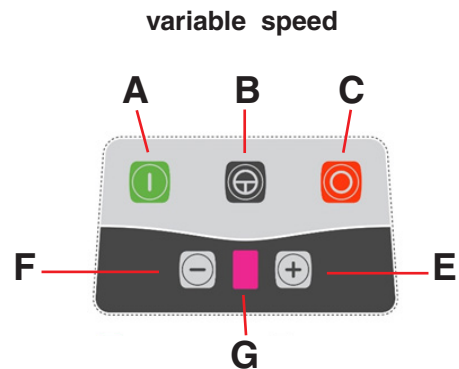

- E. Speed variation button +
- F. Speed variation button -
- G. Speed indicator

Speed mapping table :

Speed	1	2	3	4	5	6	7	8	9
Tr/min	516	638	730	830	1180	1600	1850	2940	3600

- Put the interruptor in position **I** for start-up.

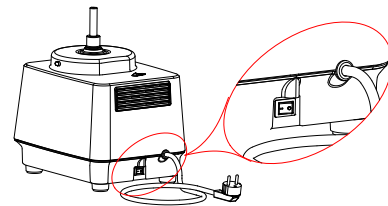

**THE USER'S SAFETY is ensured as follows:**

- The motor stops when the lid is opened.
- The motor cannot start if the container and lid are not in place.
- Compliance with the instructions in this notice on use, cleaning, and maintaining the appliance.



**Any use other than the one described in this manual is not considered 'normal' by the manufacturer.**

## COMMISSIONING/USING THE CUTTER



Before commissioning the appliance, clean all internal parts and accessories with hot water and a little detergent / degreasing agent / disinfectant compatible with the materials or with lukewarm water and neutral soap. Try to use products that are more than 90% biodegradable to reduce the emission of pollutants into the atmosphere. After that, rinse with clear water and dry thoroughly. It is recommended that you use Electrolux Professional products.



**All these actions pose the risk of cutting; never force them in, and always keep hands away from the blades.**



**Follow the work cycle of 40 minutes on and 20 minutes off, to avoid the appliance overheating.**

- The cutter comes with rotor, lid, and scraper.
- Before starting work, always check the cleanliness of the bowl, rotor, lid, scraper, and drive shaft.
- Mount the bowl on the motor unit, turn counterclockwise  to engage it, attach the rotor.
- Place the lid and turn clockwise  to engage it.
- To disassemble, proceed in reverse.

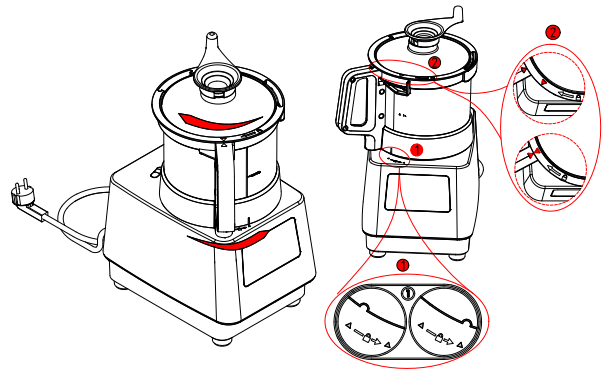

The cutter can be started if:

- The switch is in position **I**.
- The container is in position and engaged.
- The lid is secure.
- The light is green.
- If the light is orange, (or the speed indicator is flashing on model VV) one of the safety devices is not properly engaged, see Section “I” on troubleshooting.



- Constant mode: press **A**.
- Pulse mode: press **B**.
- Change speed (variable speed):
  - Select the speed on **G** by pressing **E** and **F**.
- Stop:
  - Always use the button **C** when your work is done.

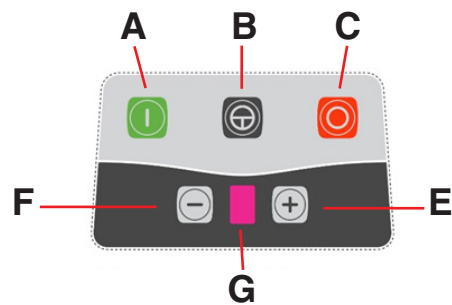

*If the machine is not in use for several days, position the switch to **O** or unplug the appliance so the electronic speed drive stops running.*



 **Always start a work at a low speed before going up the settings.**

- Use “pulse” mode to start or finish a job that requires precise supervision or a certain finish and to start processing hard products (vegetables, meats)

- As you process, turn the handle of the scraper clockwise  (as seen from above) to clean the walls of the container and lid and to process the product evenly. To remove sticky products from the scraper,

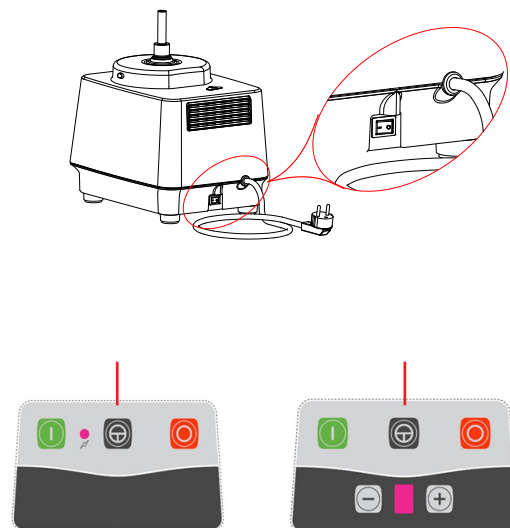



turn the handle one stroke clockwise (↻) and then counterclockwise (↺).

**• To remove the scraper :**

- Hold the scraper hub with one hand and, while applying pressure between the 2 parts, turn the handle counterclockwise (↺) (as seen from above) to disengage them.

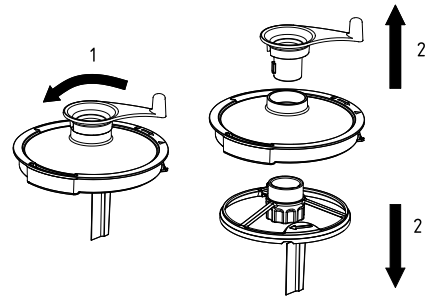

**• To attach the scraper :**

- Hold the scraper hub with one hand, place the lid over it, push the scraper handle while applying pressure between the 2 parts, turn the handle clockwise (↻) (as seen from above) to engage them.

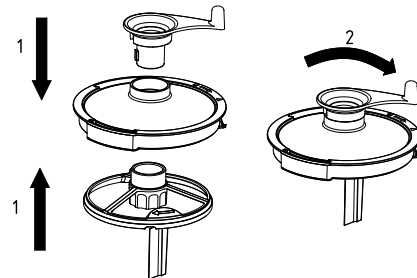

**Do not process hard products (e.g. whole vegetables, pieces of meat) with the scraper mounted.**

**Risk of damaging the scraper.**



*Note:* - Place the supplied plug in the central hole of the lid when the scraper is not in use.  
- Liquid products or ingredients can be introduced through the handle chute.  
- The tilt of the blades ensures a quick and even mixture.



When processing with liquids, do not exceed the line marked "**MAX. LIQ.**", risk of overflowing.



**For variable speed models: the appliance is not intended for processing liquid products at high speeds. If you notice any leaking around the lid, reduce the speed or reduce the contents.**

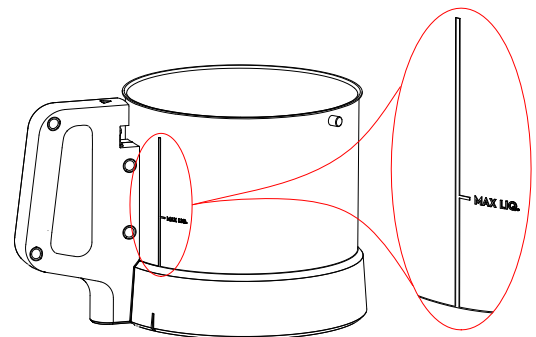

**Micro-toothed blade rotor included. Smooth blade rotor available as optional accessory.**

**Type of preparation :**

Microtoothed blade rotor for efficient chopping, mixing, grinding, emulsifying.

**Type of preparation :**

Smooth blade rotor for chopping delicate items like fresh herbs, for clean cuts like meat tartare and all preparations all where a smooth blade knife is used in the kitchen.

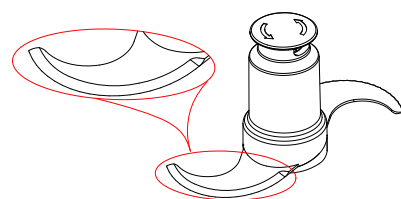
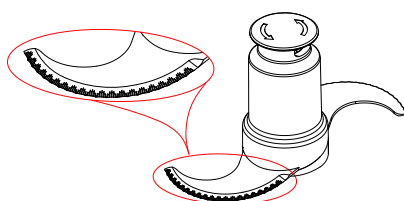

The range of bowls : \_\_\_\_\_

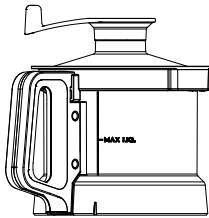

2.6L Plastic

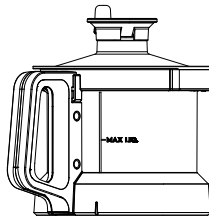

2.6L Stainless steel

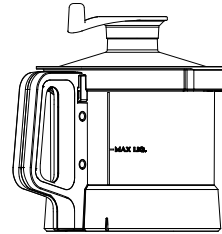

3.6L Stainless steel

## H - CLEANING AND MAINTAINING THE APPLIANCE \_\_\_\_\_



### WARNING

See "Warnings and Safety Notices".

### Routine Maintenance \_\_\_\_\_

#### Notes on Maintenance

The following maintenance tasks are the responsibility of the appliance owner and/or user.



### IMPORTANT

Problems resulting from improper maintenance or lack of maintenance as described below will void any warranty.



### WARNING

Before cleaning or maintenance, **switch off the appliance.**



### Cleaning the Appliance \_\_\_\_\_

- **To make it easier to clean the unit, systematically clean the appliance and accessories as soon as you finish working with them.**

It is recommended to clean the appliance after each use.

The bowl, lid, rotor and scraper can be cleaned in a dishwasher.

The upper green parts are dishwasher-proof.

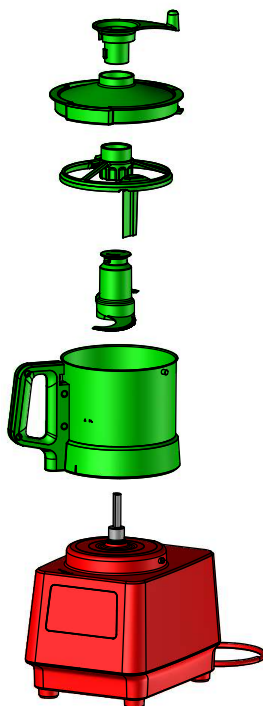



## CAUTION

- Clean the outside of the cutter with a damp sponge and mild detergent, then rinse with a clean sponge and dry.



Note: - Do not use abrasive detergents that scratch surfaces.

Do not use metal scourers or other similar materials to clean surfaces. It is recommended that you use Electrolux Professional products.



**The use of chlorinated products, and in particular those containing didecyldimethylammonium chloride (CAS 7173-51-5), is strongly discouraged.**

If, however, a specific cleaning procedure requires the use of such products, carefully respect the dosages and instructions recommended by the manufacturer.

**Rinse surfaces thoroughly with clean water and then dry.**

Misuse (overdosage, inadequate rinsing) can cause irreversible damage to the surfaces (including aluminum and stainless steel).

**The guarantee is void if these instructions are not followed.**



## ADJUSTMENT TO SAFETY FEATURES

- **Before each use, verify the proper functioning of safety devices.**

The motor must stop in 2 seconds :

- When the lid and/or the bowl is unlocked.

- **If one of these safety functions is not implemented:**

- Do not use the appliance.
- Have it adjusted by your local dealer's service department.

# I - TROUBLESHOOTING

Follow the instructions provided and contact your after-sales agent if necessary, remembering to:

1. Unplug the appliance from the main power supply
2. Cut off the protective circuit breaker upstream of the appliance

Some faults can be fixed easily and quickly, just by following the instructions in this troubleshooting guide:

Problem	Possible causes	Actions
The appliance does not turn on.	<ol style="list-style-type: none"> <li>1 There is no power supply.</li> <li>2 Main switch set to <b>0</b> (Off).</li> <li>3 Motor overheating and thermal protection intervention.</li> </ol>	<ol style="list-style-type: none"> <li>1 Be sure to plug the equipment into a powered socket.</li> <li>2 Set main switch to <b>I</b> (On).</li> <li>3 Let the equipment cool down for 30 min.</li> <li>4 If the problem persists, call service</li> </ol>
<p>Single speed model : The appliance is on but the light is still orange.</p> <p>Variable speed model : The appliance is on but the light is flashing.</p>	<ol style="list-style-type: none"> <li>1 The container or lid is not engaged on the appliance.</li> <li>2 The sensors are faulty.</li> <li>3 Single speed model - The heat protection of the motor is activated.</li> </ol>	<ol style="list-style-type: none"> <li>1 Check that these are in place.</li> <li>2 Call service.</li> <li>3 Let the equipment cool down for 30 min.</li> <li>4 If the problem persists, call service</li> </ol>
Single speed model : The appliance does not start, the light is green.	Circuit breaker intervention.	<p>Unplug the equipment from the electric supply.</p> <p>Manually reset the circuit breaker by gently inserting a screwdriver in the reset hole on the bottom of the motor base.</p>  <p>If the problem persists, call service</p>
The appliance does not start.	Electric or electronic fault.	Call service.
Abnormal noise.	<ol style="list-style-type: none"> <li>1 The motor base is not resting properly and firmly on the work surface.</li> <li>2 The accessories inside the hopper or bowl are not properly fixed.</li> <li>3 Scrape off food residues stuck under the ejector or rotor.</li> </ol>	<ol style="list-style-type: none"> <li>1 Clean the work surface and make sure the motor base rests properly on it.</li> <li>2 Make sure you have assembled the parts correctly.</li> <li>3 Clean the inside of the hopper or bowl making sure to remove any food residues.</li> <li>4 If the problem persists, call service.</li> </ol>

If the fault persists after completing the checks described above, contact your after-sales agent, giving them the following information:

- A. The problem
- B. PNC (production number code) of the appliance see chapter C.
- C. Serial number of the appliance see chapter C.

NOTE!

The PNC and serial number are essential for identifying the type of appliance and its date of manufacture.